





EUROPEAN PATENT APPLICATION

 Application number: 89313027.8

 Int. Cl.⁵ **A61H 23/02, A61G 7/00, A61H 1/00**

 Date of filing: 13.12.89

 Priority: 16.12.88 GB 8829483

 Applicant: **ARENA SYSTEMS LIMITED** trading as **CONTOUR BEDS**
 Units 7 & 8 Anglesey Business Park
 Littleworth Road Hednesford
 Nr. Cannock Staffs WS12 5NR(GB)

 Date of publication of application: 20.06.90 Bulletin 90/25

 Inventor: **Alderton, Anthony Peter**
 9 Alwyne Place Canonbury
 Islington London N1 2NL(GB)
 Inventor: **Walker, Robert**
 41 Hillside Drive Little Haywood
 Staffordshire ST18 0NN(GB)

 Designated Contracting States:
AT BE CH DE ES FR GB GR IT LI LU NL SE

 Date of deferred publication of the search report: 12.09.90 Bulletin 90/37

 Representative: **Hands, Horace Geoffrey et al**
GEORGE FUERY & CO Whitehall Chambers
 23 Colmore Row
 Birmingham B3 2BL(GB)

 **Relaxation and massage apparatus.**

 The invention provides a bed having a series of panels which can be adjusted between a co-planar flat position and one in which the panels are inclined to one another, with motor means for raising and

lowering the panels, further motor means for vibrating the panels to provide a massage effect, and infra red control apparatus for said motors.

EP 0 373 912 A3

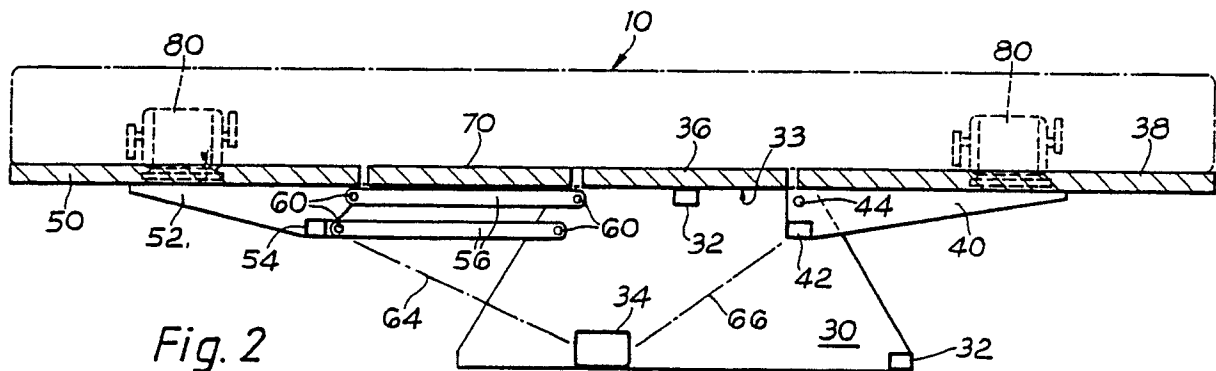

Fig. 2



DOCUMENTS CONSIDERED TO BE RELEVANT			
Category	Citation of document with indication, where appropriate, of relevant passages	Relevant to claim	CLASSIFICATION OF THE APPLICATION (Int. Cl.5)
Y	US-A-3 644 946 (SWATT) * Abstract; column 2, lines 60-66; figure 3; column 3, lines 23-27 * ---	1,2,4	A 61 H 23/02 A 61 G 7/00 A 61 H 1/00
Y	US-A-3 092 100 (OETINGER) * Column 3, lines 29-44; figures 1,2,5 *	1,2,4	
A	---	3	
A	US-A-4 229 983 (MORITA) * Column 1, lines 7-11; figures 1,5,6 * ---	4	
A	US-A-3 137 773 (BLACK) * Column 1, lines 18-23; figure 1 * ---	1	
A	US-A-3 716 876 (PETZON et al.) * Column 4, lines 22-25; abstract; figure 2 * -----	5	
			TECHNICAL FIELDS SEARCHED (Int. Cl.5)
			A 61 G A 61 H
The present search report has been drawn up for all claims			
Place of search THE HAGUE		Date of completion of the search 20-05-1990	Examiner PAPONE F.
<p>CATEGORY OF CITED DOCUMENTS</p> <p>X : particularly relevant if taken alone Y : particularly relevant if combined with another document of the same category A : technological background O : non-written disclosure P : intermediate document</p> <p>T : theory or principle underlying the invention E : earlier patent document, but published on, or after the filing date D : document cited in the application L : document cited for other reasons & : member of the same patent family, corresponding document</p>			